



---

chazara







# chazara

Contemporaneo ed essenziale, Chazara presenta un design attento alle esigenze di spazio, senza trascurare la ricercatezza estetica. Protagonista di ambienti dal design semplice, ma di grande impatto.

*Contemporary and essential, Chazara has a design that is attentive to space requirements, without neglecting aesthetic refinement. The protagonist of environments with a simple design, but of great impact.*







**Struttura:** Abete, multistrato e pannelli di particelle in legno classe E1. **Molleggio:** Cinghie elastiche in polipropilene. **Imbottitura Seduta:** Lastre di poliuretano espanso in densità 35 kg. **Imbottitura Spalliera:** Lastre in poliuretano espanso in densità 21 Kg. **Piedi:** In metallo in varie finiture h 13 cm. **Particolarità:** Le versioni sono dotate di poggiatesta sollevabile manualmente. Disponibile, a richiesta, il poggiatesta elettrico solo per le versioni con meccanismo elettrico di seduta. Dolby e subwoofer integrato nella struttura e sistema 4D nelle sedute. **Note:** Cuscini seduta, braccioli e schienali sono fissi.

**Frame:** Pinewood, multilayer wood and chipboard wood class E1. **Suspension:** Polypropylene elastic belts. **Seat Padding:** Layers of non-deformable polyurethane foam 35 Kg density. **Back Padding:** Layers of non-deformable polyurethane foam 21 Kg density. **Feet:** Metal feet in various finishes h 13 cm. **Peculiar:** All covers are equipped with a manual headrest. Recliner "Zero Wall" System with electrical function and, Headrest System (GO-UP) with electrical function, available on demand. Dolby and subwoofer integrated into the structure and 4D system in the seats. **Note:** Seat, arms and back cushions are fixed.

**Carcasse:** Hêtre + panneaux de particules cl. E1. **Suspension:** Sangle lastiques haute resistance. **Coussins d'assise:** Polyurethane expans densité 35 Kg. **Coussins de dos:** Polyurethane expans densité 21 Kg. **Pieds:** En métal différentes finitions h 13 cm. **Divers:** Têteire réglable manuellement sûr toutes les versions. Mécanisme "zero wall system" relax électrique et tetieres réglables electriquement en option, sur demande. Dolby and subwoofer integrated into the structure and 4D system in the seats. **Note:** Coussins d'assise, du dossiers et accoudoir sont fixes.

Piedi | Colore piedi | Feet | Color Feet | Pieds | Couleur Pieds

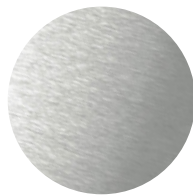
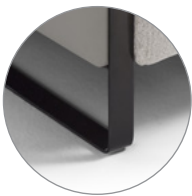

Satinato

Bronzo scuro

Taste the difference!  
**4D EXPERIENCE** with



altezza, height, hauteur: 73/102 cm [28-40"]

altezza seduta, seat height, hauteur du si ge: 46 cm [18"]

profondit , depth, profondeur: 112 [44"]

profondit  seduta, seat depth, profondeur d'assise: 59 cm [23"]

altezza piede, feet height, hauteur des pieds: 13 cm [5"]

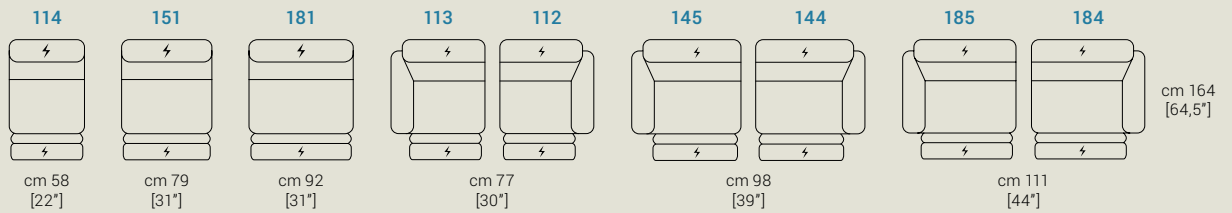
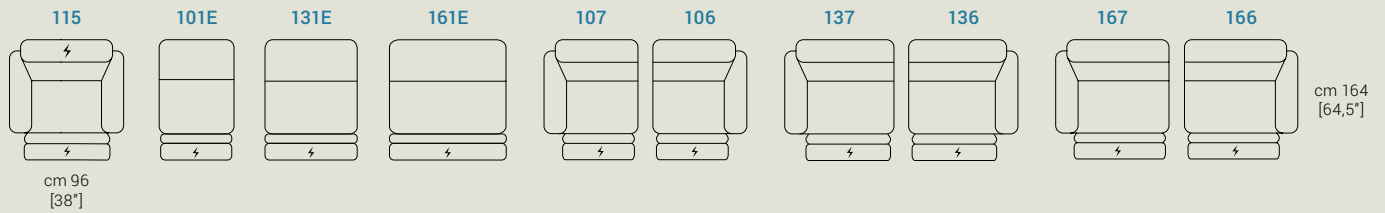
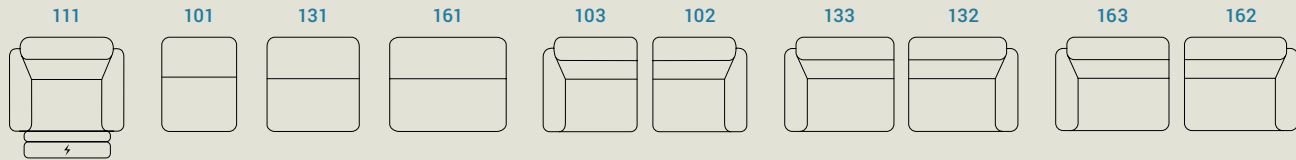
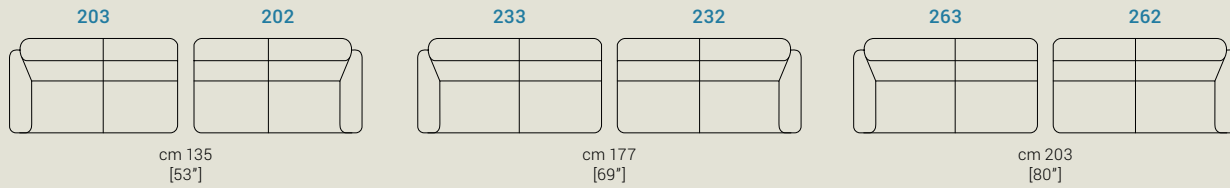
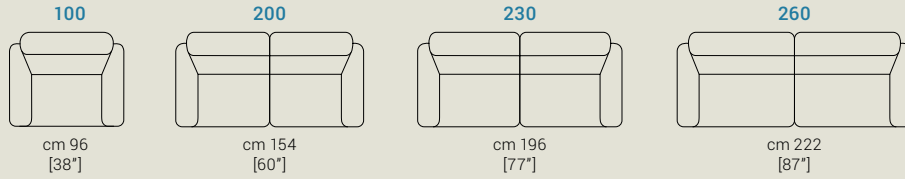



# chazara

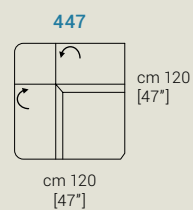
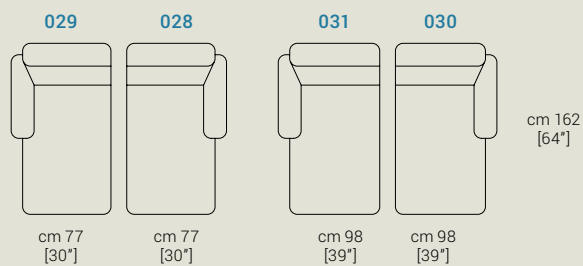
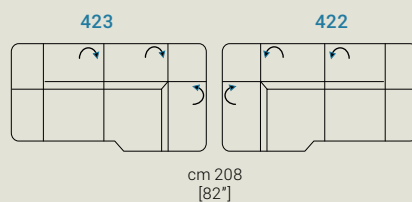
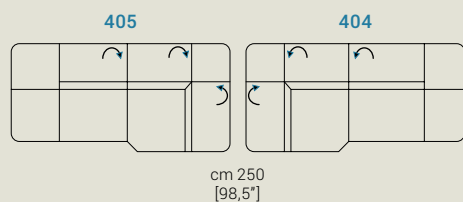
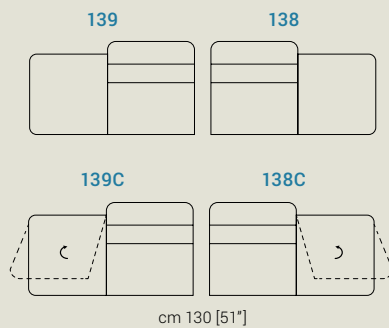
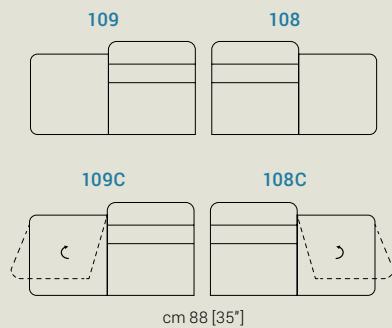
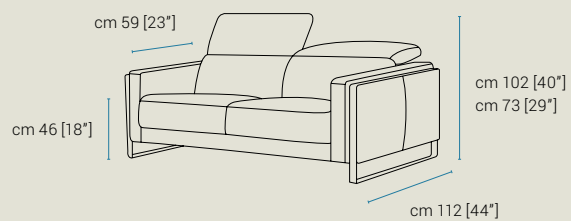

# chazara

## 4D experience

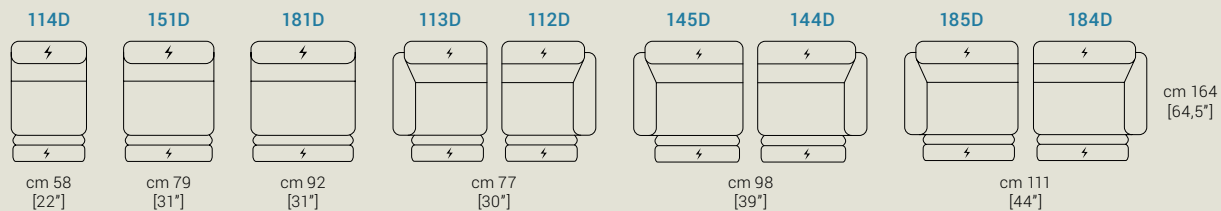
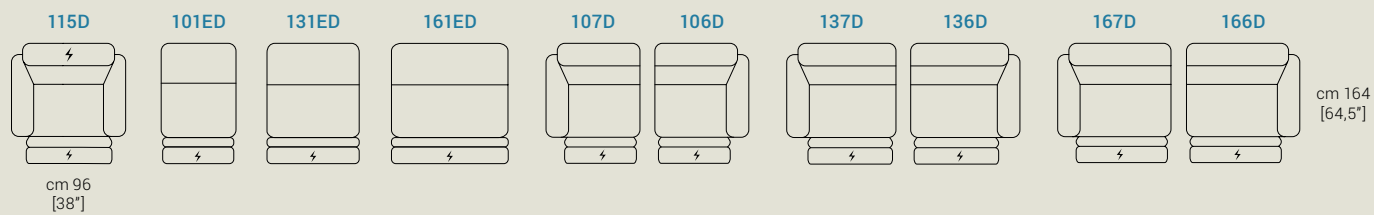
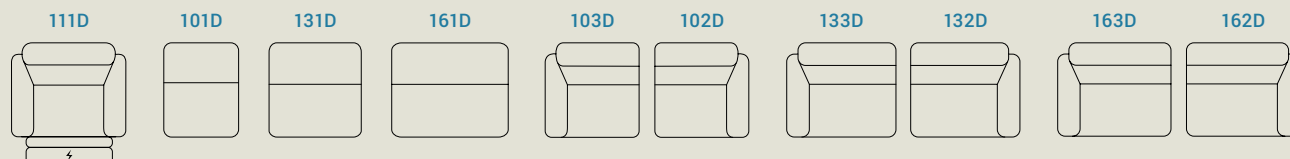
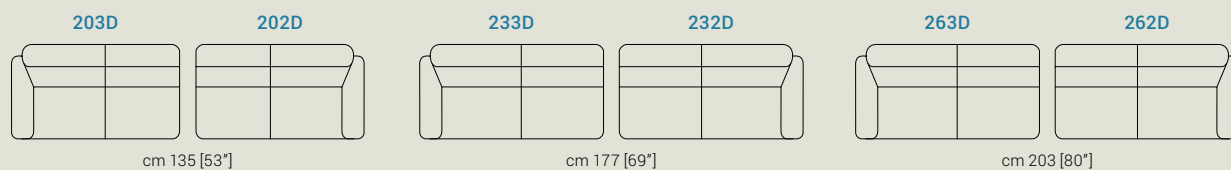
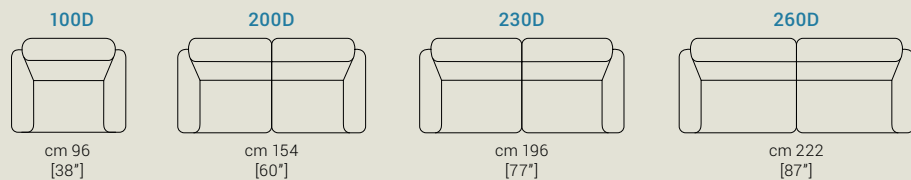

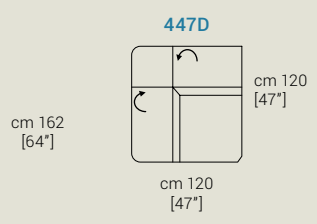
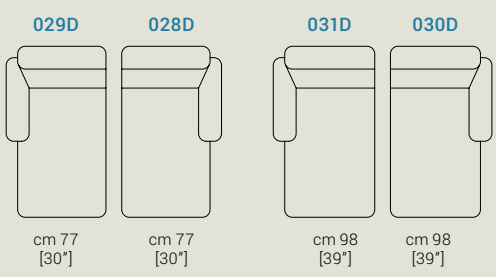
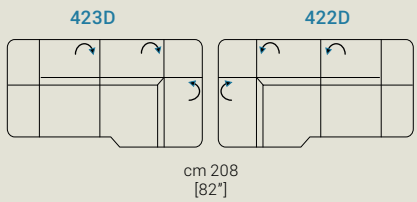
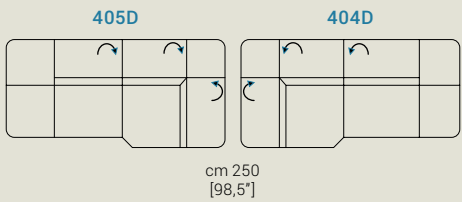
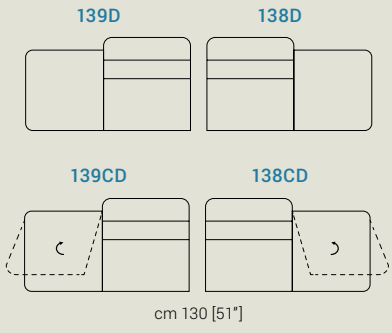
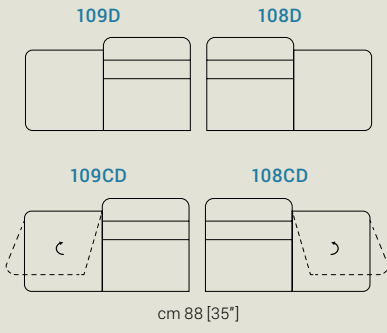

**Glamour Sofà Srl**

**Sede Legale**

P.zza Aldo Moro, 7

**Sede Operativa**

Via dell'Avena - Angolo Via del Lino, Z.I.

70022 Altamura (BA)

(+39) 080 40 30 636

[info@glamoursofa.it](mailto:info@glamoursofa.it)